

6-CNJ-110 @10hr

CNJ series GEL battery utilizes AGM and gel mixed technology, composed of strong grids, high purity lead and fumed silica Gel electrolyte with good cycle life and wide temperature range performance. The unique plate design and patented structure design provides the excellent frequent cyclic discharge performance.

SPECIFICATION

Nominal Voltage	12V (6 cells)
Nominal Capacity	
10-Hr Rate to 10.8V @ 25°C(77°F)	110Ah
Approximate Net Weight	31 kg (68.3 lbs) (±2%)
Max. Charging Current	27.5A
Cycle Use Charging	14.4V @25°C(77°F)
Terminal	M8-Φ18
Operating Temperature Range	-35°C to 60°C(-31°F~140°F)
Advice operating temperature	15°C~25°C(59°F~77°F)
Self Discharge	
1 month	97%
3 month	91%
6 month	83%
HUAFU CNJ series deep cycle gel battery self-discharge <3%/month@25°C(77°F), can be stored up to 6 months at 25°C(77°F) and then a freshening charge is required. If the storage temperature higher than 25°C(77°F), a freshening recharge will be required sooner.	
Case and cover	A.B.S. UL94-V0 Optional.
Design Life time	12 years

DIMENSIONS (mm)

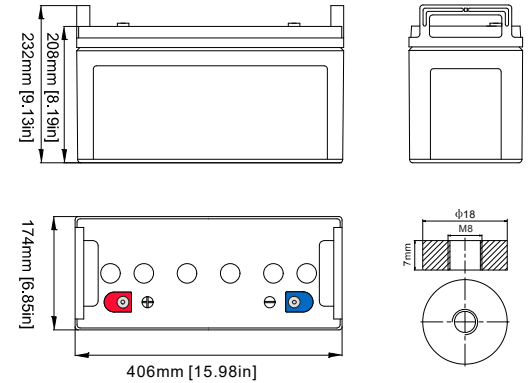

FEATURE

- Specifically designed for Solar and energy storage applications
- Use multiple rare-earth alloy of independent intellectual property right and special lead paste formulations
- Usage of imported low -resistant raw materials and advanced process
- Patented nanometer level gel electrolyte
- Low self-discharge rate, better deep discharge tolerance, strong recover capability of capacity
- Wide temperature range
- Valve regulated, maintenance free non-spillable

BATTERY CONSTRUCTION

Positive	Negative Plate	Container	Cover	Safety valve	Terminal	Separator	Electrolyte
Lead dioxide	Lead	ABS	ABS	Rubber	Copper	AGM	Gel



PARENT COMPANY: HUAFU High Technology Energy Storage Co., Ltd.

SUBSIDIARY: Jiangsu HUAFU Power Co., Ltd. / HUAFU (Jiangsu) Lithium Battery High Technology Co., Ltd.

Add: Battery Industrial Park, Economic Development Zone, Gaoyou City 225600, Jiangsu Province, China
 Website: www.huafubattery.com Email: sales_export@cnhuafu.com Tel: +86-514-84543660

6-CNJ-110 @10hr

Charge Curve (solar panel)

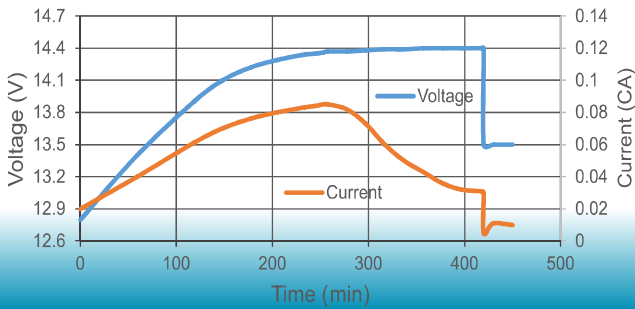

Discharge Curve (25 °C)

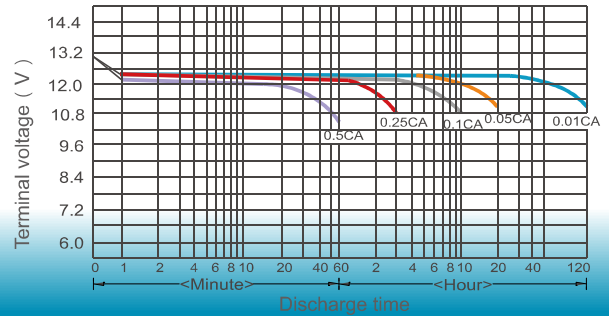

Cycle Life Vs Depth of Discharge

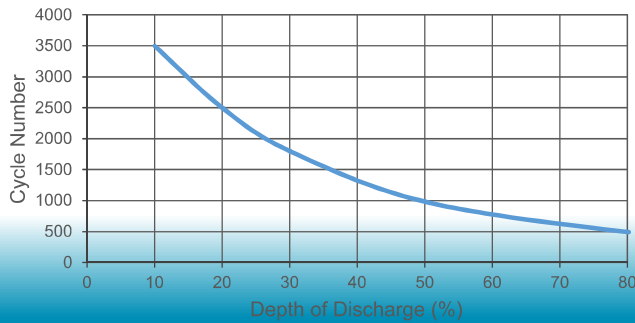

Temperature Vs Battery Capacity

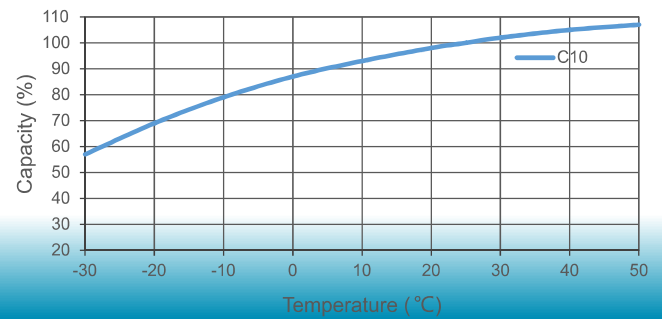

Self Discharge Characteristics

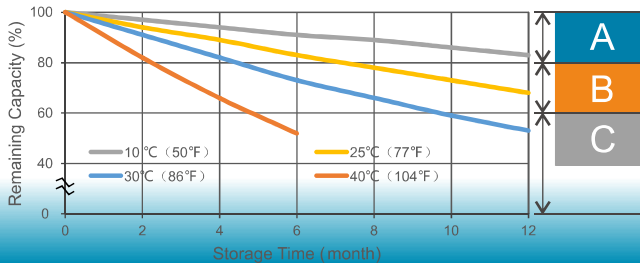

- A** Charging is not necessary unless 100% of capacity is required.
- B** Charging before use is necessary to help recover full capacity.
- C** Charging may fail to restore full capacity. Do not let batteries reach this state.

Charging Voltage VS Temperature

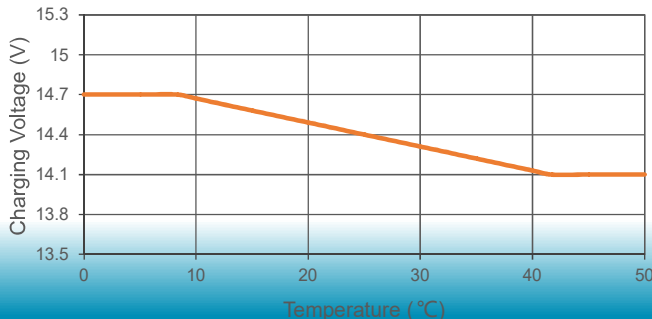

Cycle Use: Apply constant voltage charge 14.4V at 25°C. Initial charging current should be set at less than 0.25C Amps. Switch to float charge to avoid overcharging.

Temperature Compensation: Charging Voltage for both Cyclic and Standby applications should be regulated in relation to ambient temperature. As temperature rises charging voltage should be reduced to prevent overcharge and increased as temperature falls to avoid undercharge. 3 mV/cell/°C.

APPLICATION

A whole range of CYCLIC applications including but not limited to:

- Solar / wind system
- Medical equip
- Lighting system
- Inverter
- RV
- Power Station



PARENT COMPANY: HUAFU High Technology Energy Storage Co., Ltd.

SUBSIDIARY: Jiangsu HUAFU Power Co., Ltd. / HUAFU (Jiangsu) Lithium Battery High Technology Co., Ltd.

Add: Battery Industrial Park, Economic Development Zone, Gaoyou City 225600, Jiangsu Province, China

Website: www.huafubattery.com

Email: sales_export@cnhuafu.com

Tel: +86-514-84543660